

ACVD ALUMINUM CURVED VANE DIFFUSER

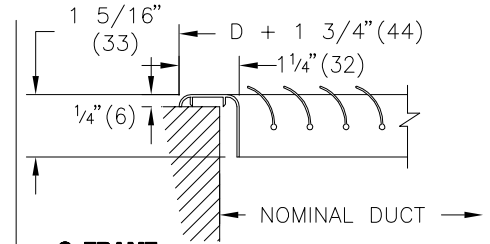

C FRAME

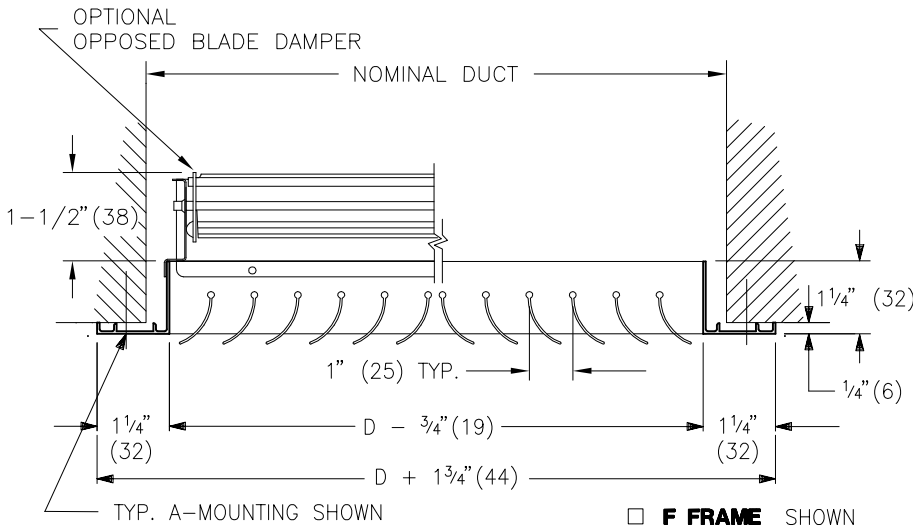
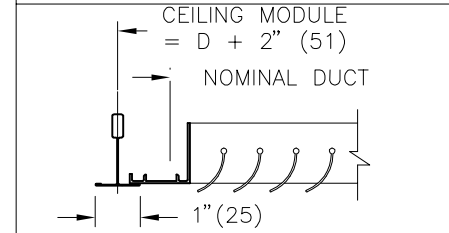

3 T-BAR

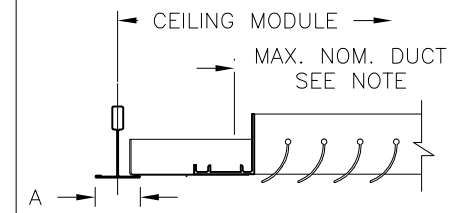

T-BAR LAY-IN PANELS: **3P** **3PA** A = 1\"/>

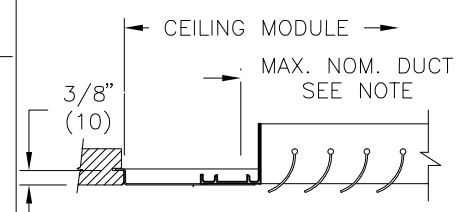

SPLINE CEILINGS: **4P** **4PA**

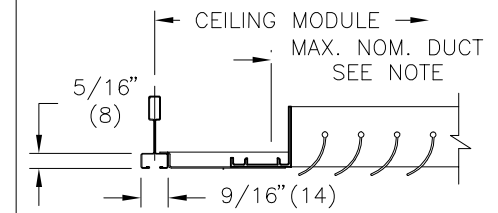

FINELINE LAY-IN PANELS: **17P** **17PA**

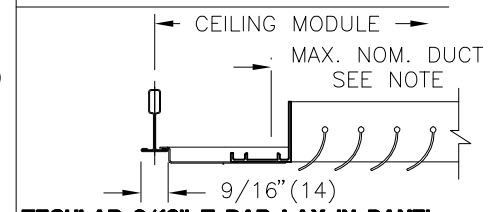

REGULAR 9/16\"/>

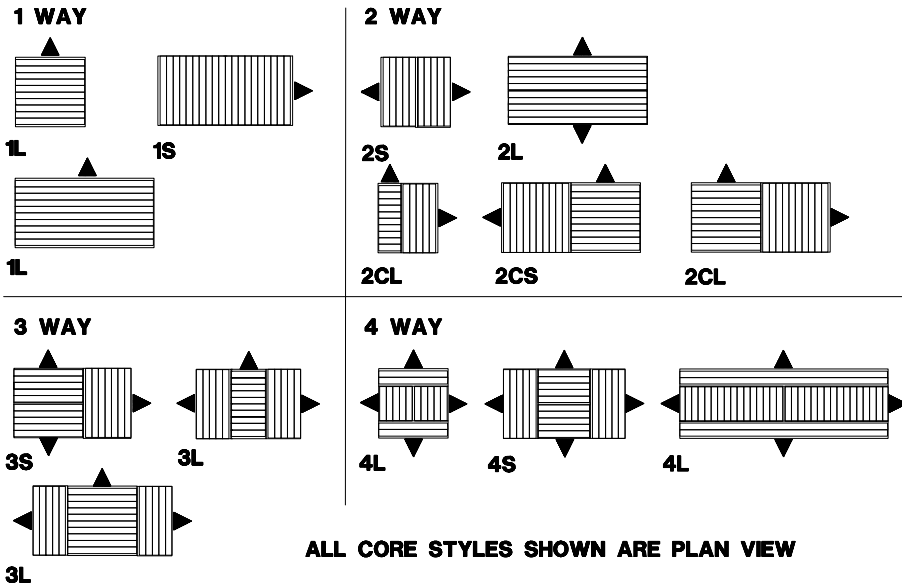

ALL CORE STYLES SHOWN ARE PLAN VIEW

MATERIAL:
• ALUMINUM

FINISH:
 B12 WHITE
(OPTIONAL FINISHES AVAILABLE)

NOTE:
SIZES 6x6 TO 24x24 AVAILABLE IN 1, 2, 3 & 4 WAY AIR PATTERNS.
AVAILABLE SIZES: 6, 8, 10, 12, 14, 16, 18, 20, 22 AND 24
4\"/>

OPTION:
 VCS3 c/w COATED STEEL OPPOSED BLADE DAMPER
 VCS3AL c/w ALUMINUM OPPOSED BLADE DAMPER MILL FINISH

ALL METRIC DIMENSIONS () ARE SOFT CONVERTED. IMPERIAL DIMENSIONS ARE CONVERTED TO METRIC AND ROUNDED TO THE NEAREST MILLIMETER.

PROJECT:	
ENGINEER:	
CUSTOMER:	
SUBMITTAL DATE:	SPEC. SYMBOL:

PRICE®

Signature

227339

2014/06/24

ACVD
ALUMINUM CURVED VANE
SUPPLY AIR DIFFUSER