

CFC - CURVED CUSTOM FLOW

DIFFUSER STYLE:

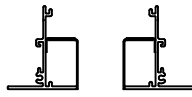

AS - Adjusta Slot



JS - Jet Slot

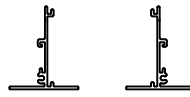

RT - Return



TMP - Template
 • Template only (no diffuser)
 • Used to verify frame opening

CURVE ORIENTATION:

FLAT - Flat Faced Curve

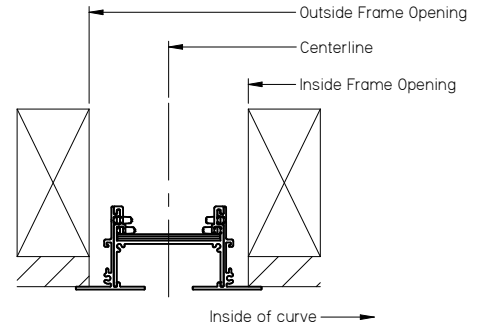
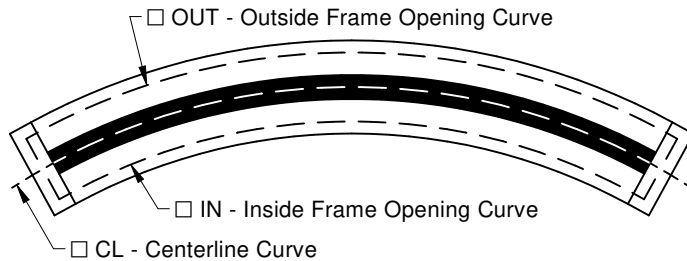

CONCAVE - Slots Facing Inside Curve

• WALL - Curved Sidewall or Arched Ceiling Curve

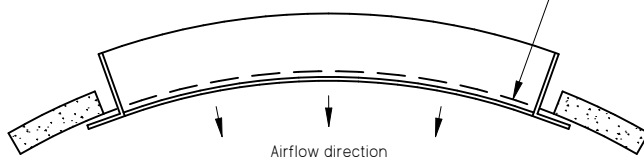

CONVEX - Slots Facing Outside Curve

• WALL - Curved Sidewall or Arched Ceiling Curve

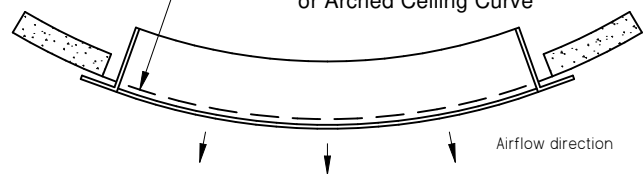

CURVE DIMENSIONS:

Please specify final curve in terms of Arc Length and Radius, which can be calculated from any 2 given dimensions using an appropriate curve calculator.

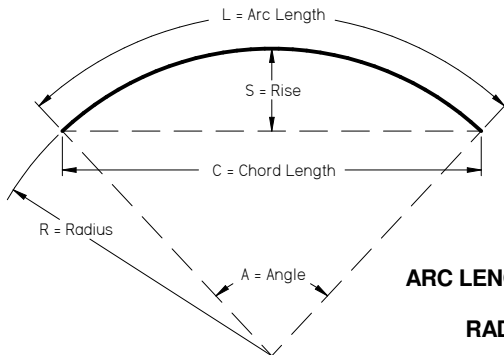

Scan or click for link to curve calculator

ARC LENGTH: _____

RADIUS: _____

Minimum Centerline Radius - FLAT Faced Curve			
Slot Width	Slot Qty.	EF	CMF
1" (25mm)	1	60" (1524mm)	112" (2845mm)
	2	60" (1524mm)	112" (2845mm)
1 1/2" (38mm)	1	60" (1524mm)	144" (3658mm)
	2	84" (2134mm)	144" (3658mm)
2" (51mm)	1	156" (3962mm)	385" (9779mm)
	2	312" (7925mm)	385" (9779mm)
2 1/2" (64mm)	1	360" (9144mm)	Special Quote
	2	1000" (25400mm)	Special Quote
3" (76mm)	1	576" (14630mm)	Special Quote
	2	1625" (41275mm)	Special Quote

*FLAT faced curves less than minimum radius, CONCAVE, and CONVEX faced curves only available through Special Quote. Special Quotes subject to increased lead times.

ALL METRIC DIMENSIONS () ARE SOFT CONVERTED. IMPERIAL DIMENSIONS ARE CONVERTED TO METRIC AND ROUNDED TO THE NEAREST MILLIMETER.

PROJECT:

ENGINEER:

CUSTOMER:

SUBMITTAL DATE:

SPEC. SYMBOL:



MG

273458

2022/01/07

CF
CURVED CUSTOM FLOW
LINEAR SLOT DIFFUSER

CFC - CURVED CUSTOM FLOW

FRAME STYLE:

SLOT QUANTITY:

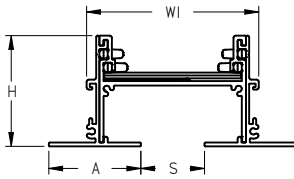

EF - Exposed Frame

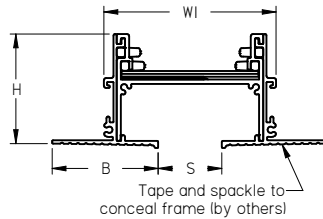

CMF - Concealed Mud Frame

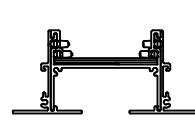

1 Slot

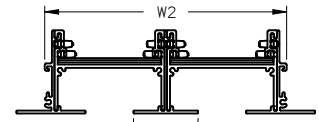

2 Slot

Slot Width (S)	A	B	H	W1 (1 Slot)	W2 (2 Slot)	T
<input type="checkbox"/> 1" (25mm)	1 7/16" (37mm)	1 11/16" (43mm)	1 3/4" (44mm)	2 3/4" (70mm)	5 1/16" (129mm)	1 3/8" (35mm)
<input type="checkbox"/> 1 1/2" (38mm)	1 11/16" (43mm)	1 15/16" (49mm)	2" (51mm)	3 3/4" (95mm)	7 1/16" (179mm)	1 7/8" (48mm)
<input type="checkbox"/> 2" (51mm)	1 15/16" (49mm)	2 3/16" (56mm)	2 1/4" (57mm)	4 3/4" (121mm)	9 1/16" (230mm)	2 3/8" (60mm)
<input type="checkbox"/> 2 1/2" (64mm)	2 3/16" (56mm)	2 3/8" (60mm)	2 1/2" (64mm)	5 3/4" (146mm)	11 1/16" (281mm)	2 7/8" (73mm)
<input type="checkbox"/> 3" (76mm)	2 7/16" (62mm)	2 5/8" (67mm)	2 3/4" (70mm)	6 3/4" (171mm)	13 1/16" (332mm)	3 3/8" (86mm)

MOUNTING:

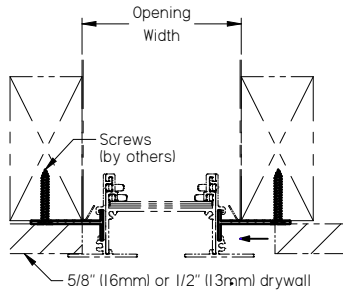

MP-DR - Reversible 1/2" or 5/8" Drywall Mtg. Clip

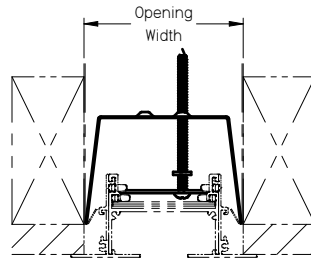

C - Concealed Mounting Bracket

• EF frame only

Slot Width	Slot Qty.	Opening Width
1" (25mm)	1	3 3/8" (86mm)
	2	5 11/16" (144mm)
1 1/2" (38mm)	1	4 3/8" (111mm)
	2	7 11/16" (195mm)
2" (51mm)	1	5 3/8" (137mm)
	2	9 11/16" (246mm)
2 1/2" (64mm)	1	6 3/8" (162mm)
	2	11 11/16" (297mm)
3" (76mm)	1	7 3/8" (187mm)
	2	13 11/16" (348mm)

*Opening width is outside dimension of field built plenum with hemmed edges. If no plenum is used, opening width may be additionally reduced by up to 1/4" (6mm).

END CONDITIONS:

W - Flanged End

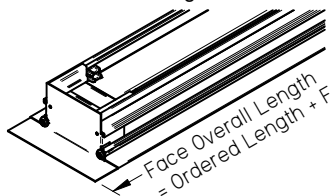

Y - Open End (for splicing together multiple sections)



Z - Flush End

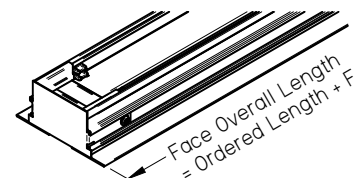

	WW	WY	WZ	F	YY	YZ	ZZ
CMF	+1 1/16" (+27mm)	+9/16" (+14mm)	+7/16" (+11mm)		0	-1/8" (-3mm)	-1/4" (-6mm)
EF	+1 1/4" (+32mm)	+5/8" (+16mm)	+1/2" (+13mm)		0	-1/8" (-3mm)	-1/4" (-6mm)

ALL METRIC DIMENSIONS () ARE SOFT CONVERTED. IMPERIAL DIMENSIONS ARE CONVERTED TO METRIC AND ROUNDED TO THE NEAREST MILLIMETER.

PROJECT:

ENGINEER:

CUSTOMER:

SUBMITTAL DATE:

SPEC. SYMBOL:



MG

273458

2022/01/07

CF
CURVED CUSTOM FLOW
LINEAR SLOT DIFFUSER

CFC - CURVED CUSTOM FLOW

NOTES:

- Minimum length 12" (305mm)
- Sizes over maximum section length will be provided in multiple sections
- For installation instructions or instructions for drywall finishing, please see CF installation manual
- Taping and plaster finishing by others
- Replacement parts can be ordered through CFK or GRD-PARTS models
- For use with model CFPC plenums
- Only compatible with model CF diffusers and MC-CF mitered corner modules
- Factory tolerance +/- 1/32" (1mm)



Scan for link to additional product information and installation instructions.

MATERIAL:

- Extruded aluminum frame, spacers, and drywall mounting clips
- Steel pattern controllers, Z endcaps, and frame opening template
- Plastic locking pins
- Coated steel fasteners and concealed mounting brackets

STANDARD FINISHES:

- Diffuser face:
 - B12 - Standard white
 - PA - Prepared and washed aluminum
- CMF outer frames come with a PA finish. On 2 slot variations, only center tee will be painted.
- Interior surface:
 - NO-BFR - Upper frame to match diffuser face
- Pattern controllers - B17 black
- Z endcaps - B17 black

OPTIONAL FINISHES AVAILABLE:

- Diffuser face:
 - Optional colors
 - Custom colors
 - Anodized
 - Armstrong coordinated finishes
 - See finishesbrochure for additional information. Contact your PRICE representative for leadtimes and pricing.

ALL METRIC DIMENSIONS () ARE SOFT CONVERTED. IMPERIAL DIMENSIONS ARE CONVERTED TO METRIC AND ROUNDED TO THE NEAREST MILLIMETER.

PROJECT:			
ENGINEER:			
CUSTOMER:		CF CURVED CUSTOM FLOW LINEAR SLOT DIFFUSER	
SUBMITTAL DATE:	SPEC. SYMBOL:		